 BREM SYSTEME <small>GMBH</small> WANDSCHUTZ · HANDLAUFSYSTEME	Boschstraße 7, D-94405 Landau/Isar 09951/6903-0, info@brem-systeme.de		
Wandschutz Typ 13 sichtbar geschraubt Querschnitt			
Bearb.: W. Mader	Z.Nr. 1.002W13	20.07.2011	M 1:1

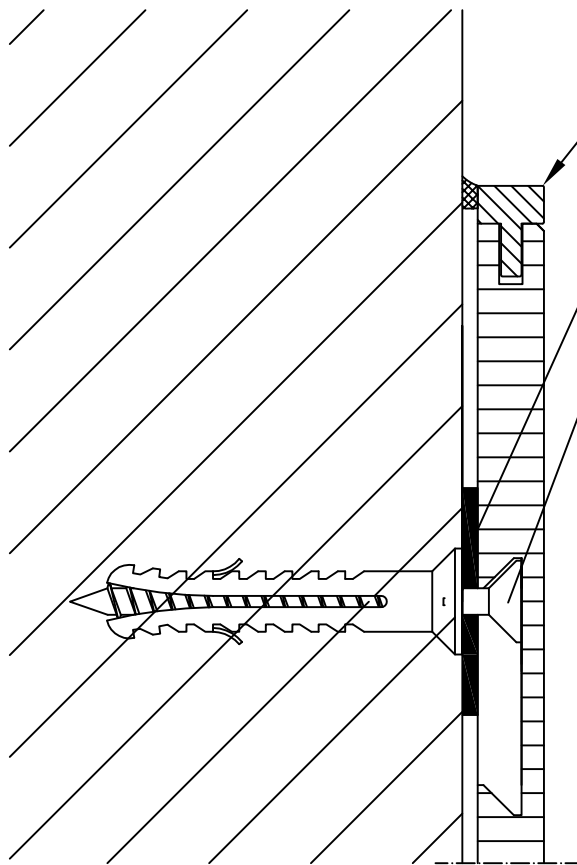

Profil A3

2mm Distanzscheibe D=30/6

6 mm Senkkopfschraube

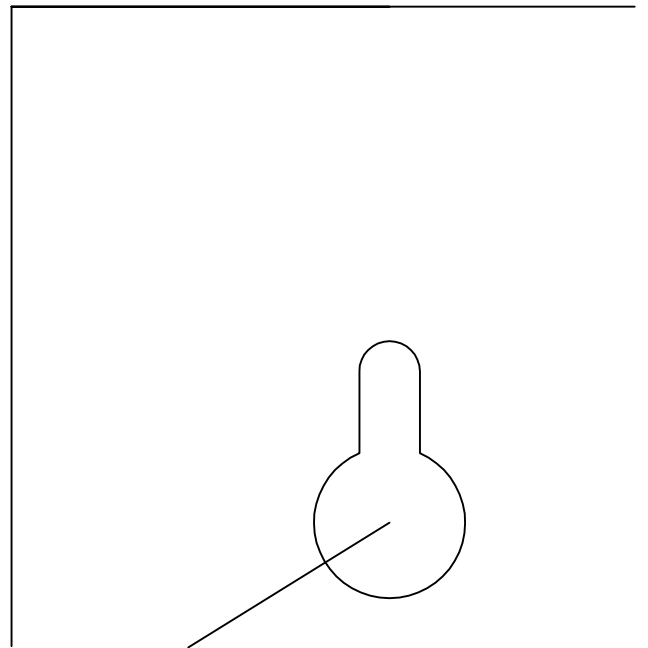

Rückseitige
Schlüsselloch-Einhängefräsung

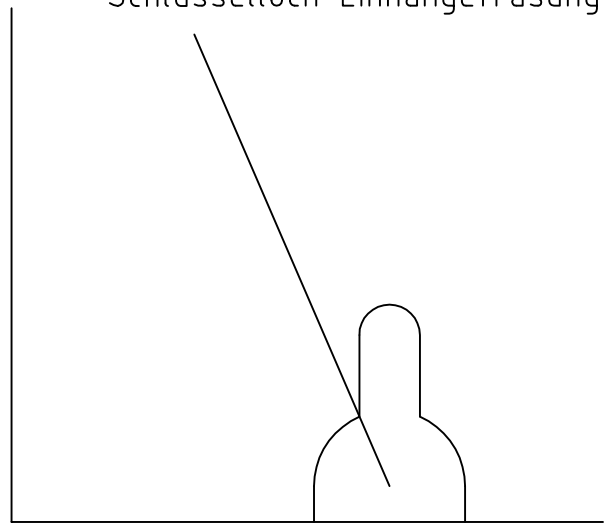
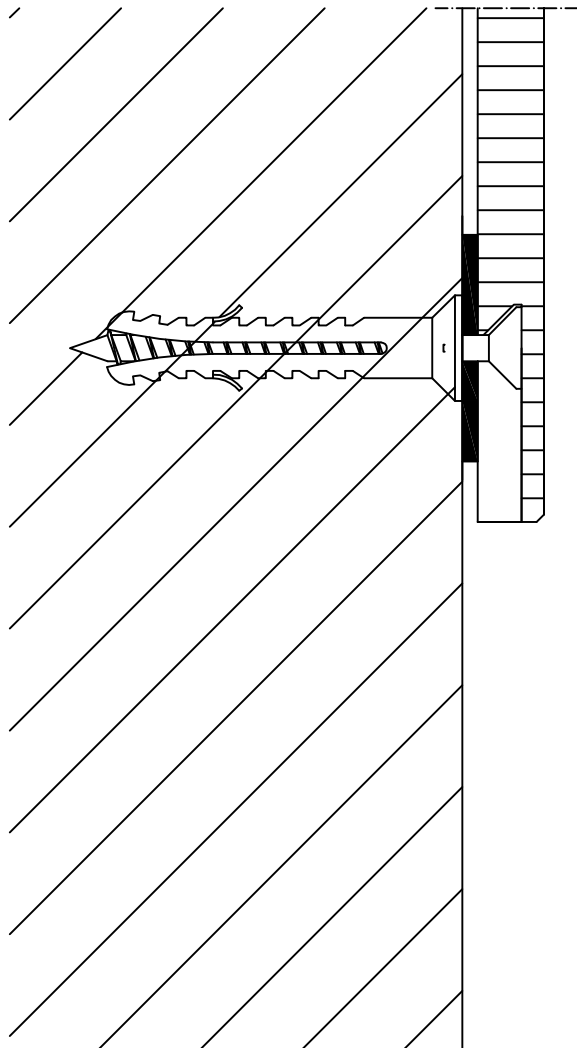

 BREM SYSTEME <small>GMBH</small> WANDSCHUTZ · HANDLAUFSYSTEME	Boschstraße 7, D-94405 Landau/Isar 09951/6903-0, info@brem-systeme.de
	Wandschutz Typ 13 mit rückseitiger Einhängefräsung Querschnitt

Bearb.: W. Mader	Z.Nr. 1.003W13	20.07.2011	M 1:1
------------------	----------------	------------	-------

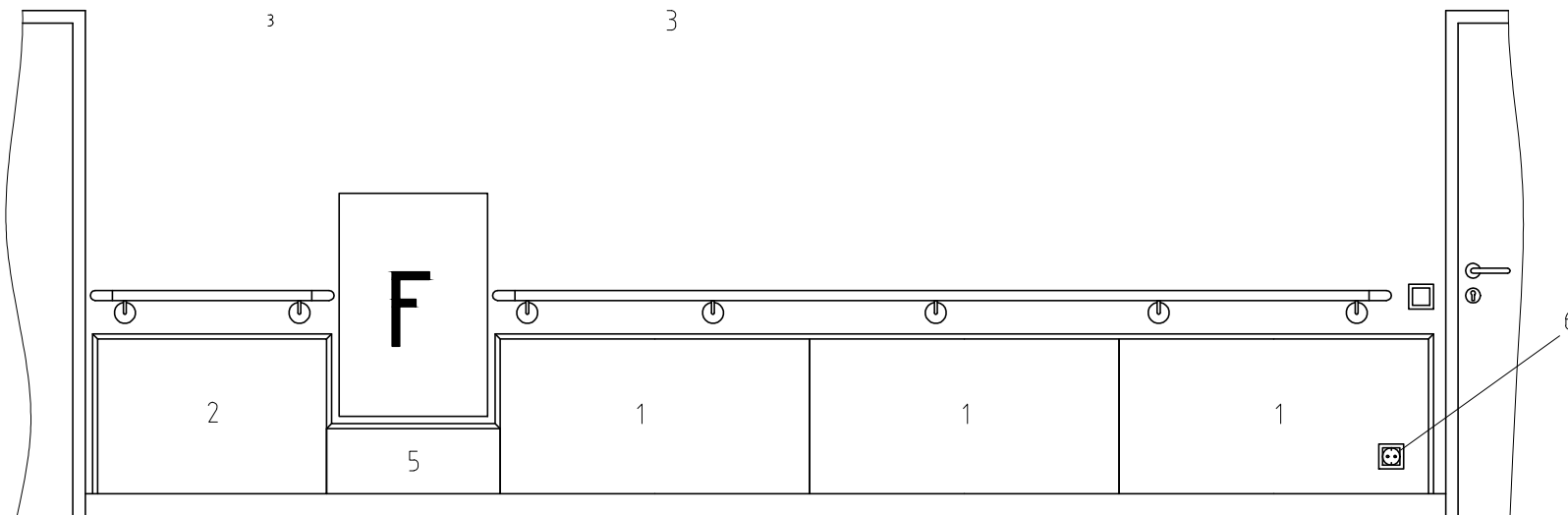
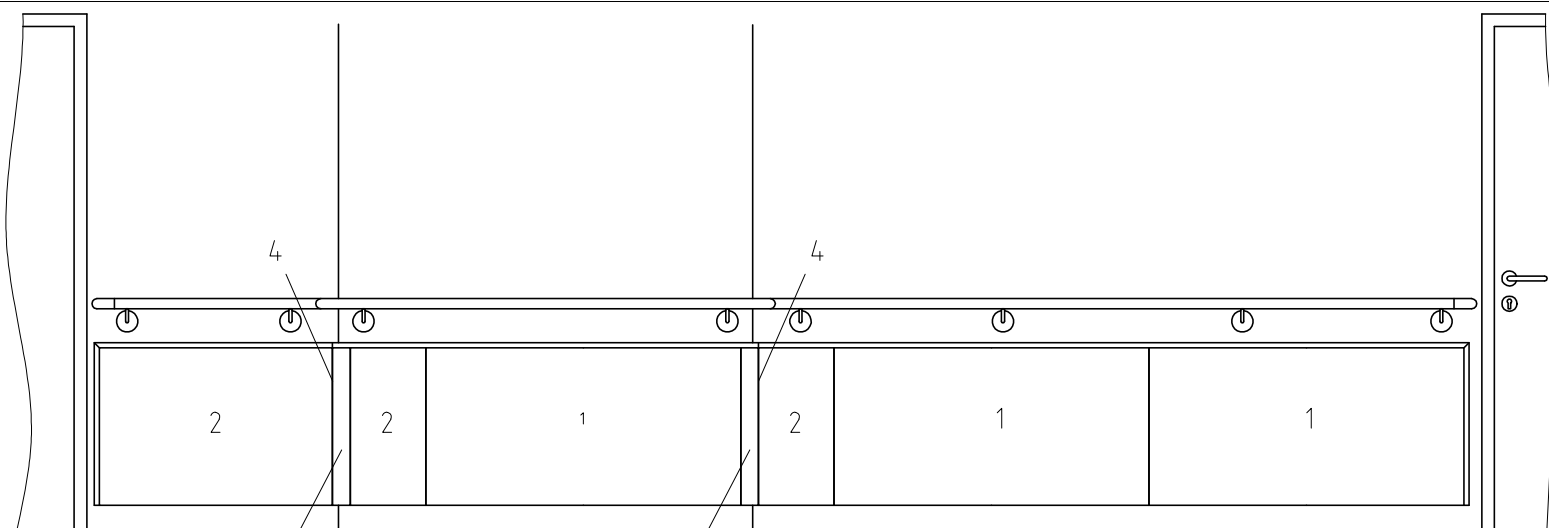

- 1 Rasterpaneel ca. 1300
- 2 Passpaneel >300
- 3 Ausseneck 70x70
- 4 Inneneck
- 5 Revisionsaussparung
- 6 Steckdosenaussparung

 BREM SYSTEME <small>GMBH</small> WANDSCHUTZ · HANDLAUFSYSTEME	Boschstraße 7, D-94405 Landau/Isar 09951/6903-0, info@brem-systeme.de		
	Wandschutz Typ 13 Wandschutz Zulagen, verdeckt befestigt Ansicht		
Bearb.: M.Fischer	Z.Nr. 6.001W13	28.10.2015	M 1:30

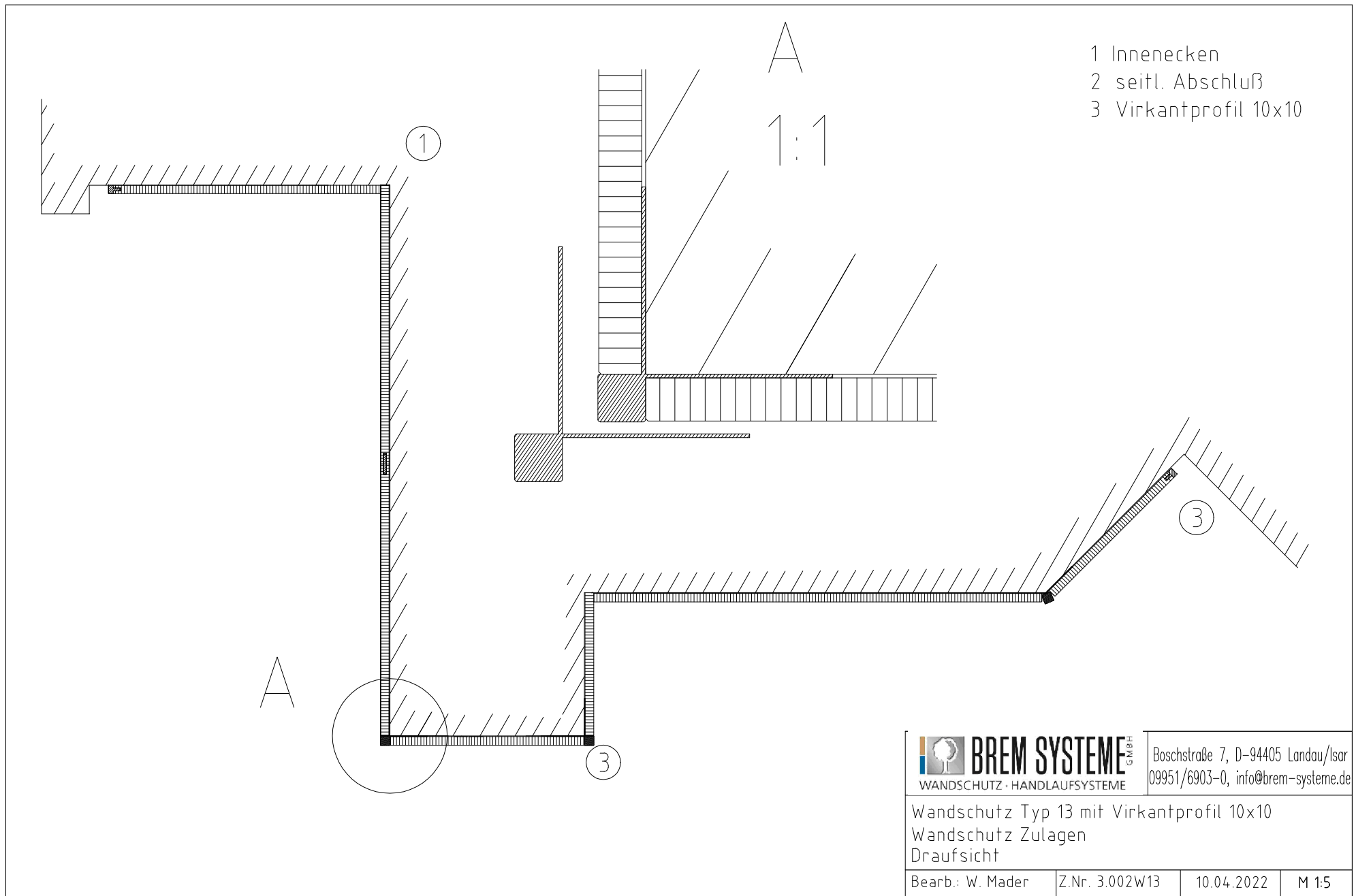

- 1 Innenecken
- 2 seitr. Abschluß
- 3 Virkantprofil 10x10

A
1:1

A

 BREM SYSTEME <small>GMBH</small> WANDSCHUTZ · HANDLAUFSYSTEME	Boschstraße 7, D-94405 Landau/Isar 09951/6903-0, info@brem-systeme.de		
	Wandschutz Typ 13 mit Virkantprofil 10x10 Wandschutz Zulagen Draufsicht		
Bearb.: W. Mader	Z.Nr. 3.002W13	10.04.2022	M 1:5

- 1 Innenecken
- 2 seifl. Abschluß
- 3 Edelstahlwinkel

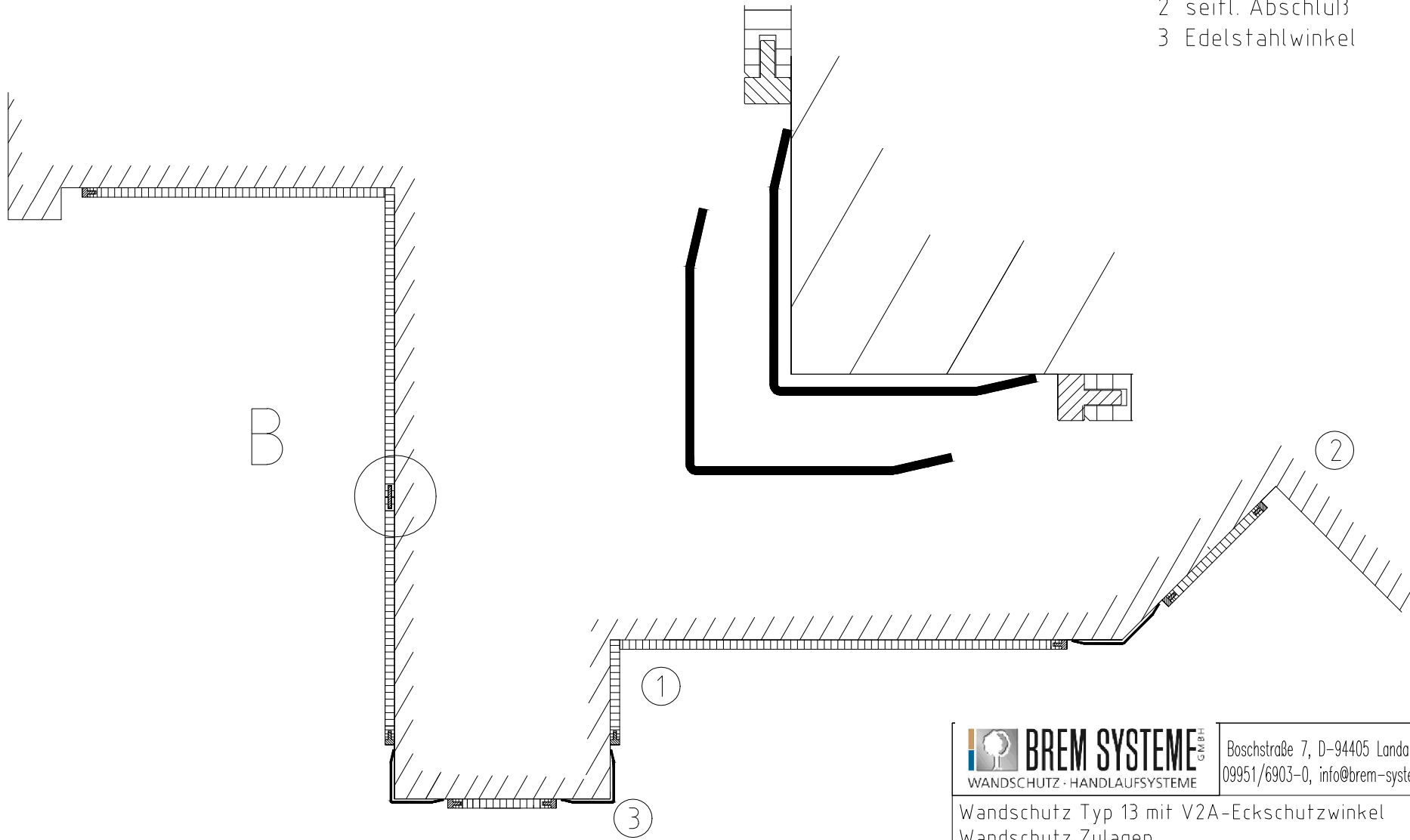

 BREM SYSTEME <small>GMBH</small> WANDSCHUTZ · HANDLAUFSYSTEME	Boschstraße 7, D-94405 Landau/Isar 09951/6903-0, info@brem-systeme.de		
	Wandschutz Typ 13 mit V2A-Eckschutzwinkel Wandschutz Zulagen Draufsicht		
Bearb.: W. Mader	Z.Nr. 3.002W13	10.04.2022	M 1:5

- 1 Innenecke
- 2 Aussenecke als Kompaktformingteil 135°
- 3 Aussenecke als Kompaktformingteil 90°

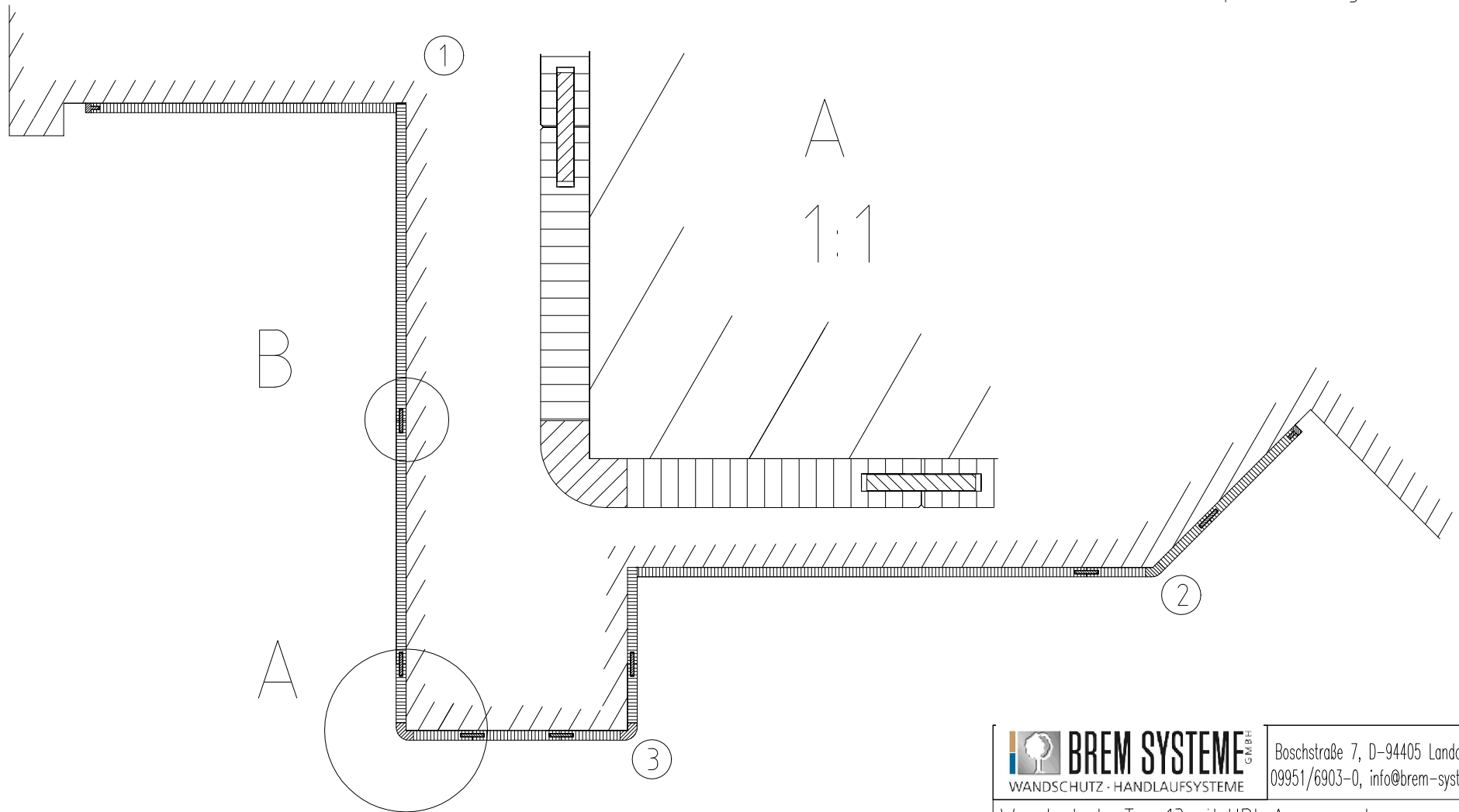

 BREM SYSTEME <small>GMBH</small> WANDSCHUTZ · HANDLAUFSYSTEME	Boschstraße 7, D-94405 Landau/Isar 09951/6903-0, info@brem-systeme.de		
	Wandschutz Typ 13 mit HPL Aussenecken Wandschutz Zulagen Draufsicht		
Bearb.: W. Mader	Z.Nr. 3.001W13	10.04.2022	M 1:5

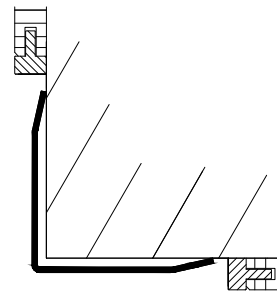
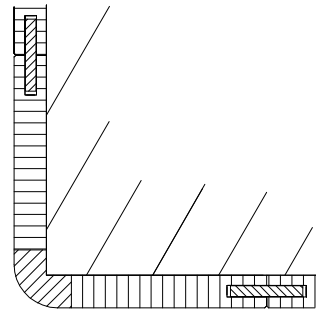
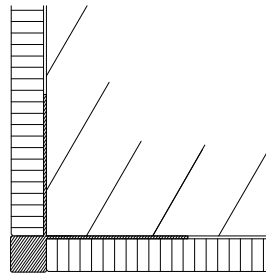

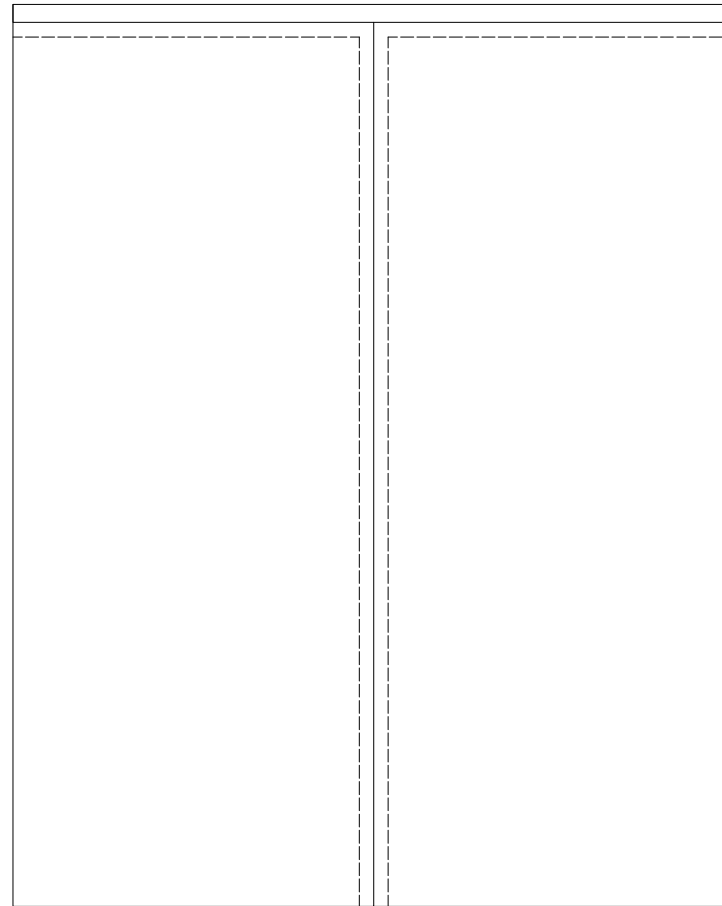

Stoß

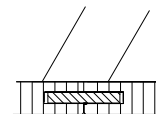

B

1:1



 BREM SYSTEME WANDSCHUTZ · HANDLAUFSYSTEME	<small>GMBH</small> Boschstraße 7, D-94405 Landau/Isar 09951/6903-0, info@brem-systeme.de		
Wandschutz Typ 13			
Bearb.: M.Fischer	Z.Nr. 8.003W13	10.04.2022	M 1:1

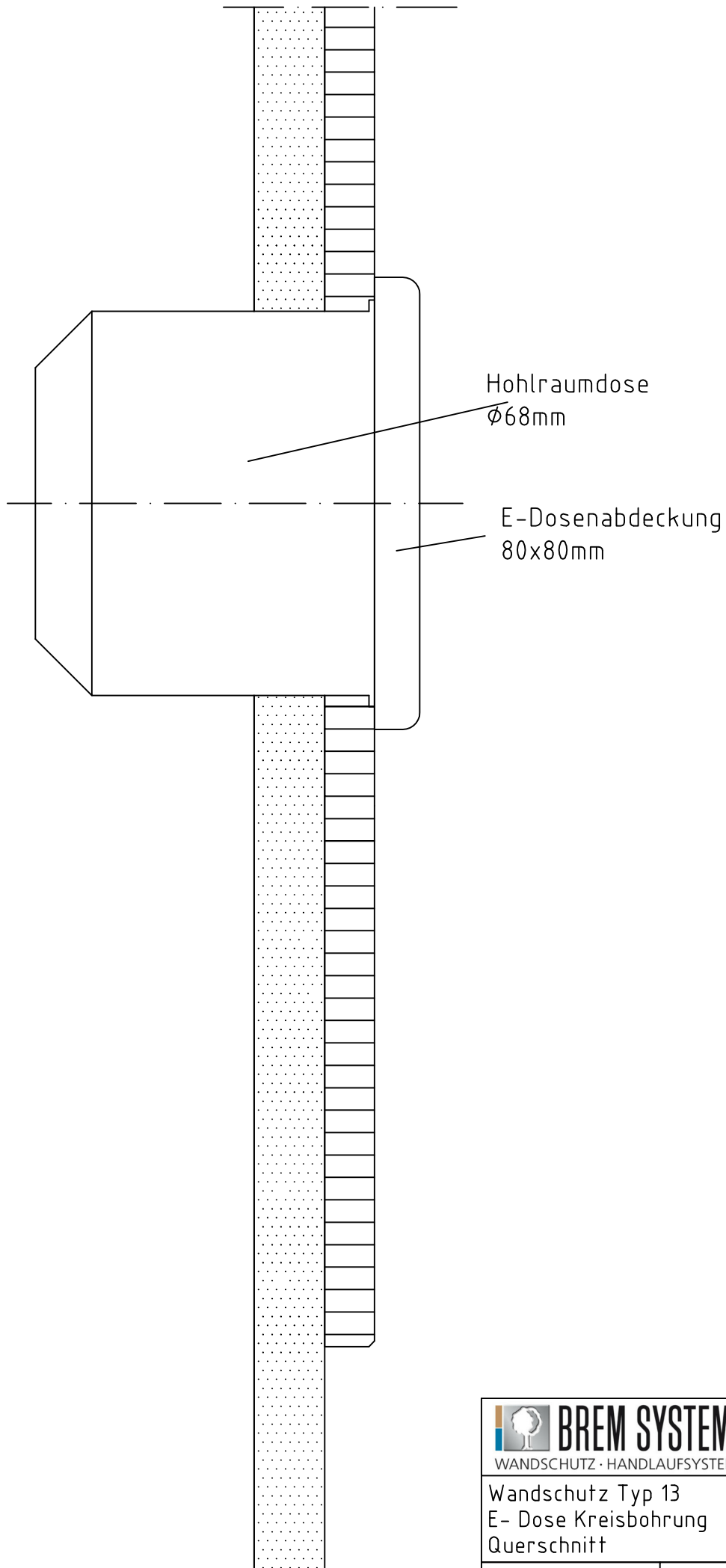

 BREM SYSTEME <small>GMBH</small> WANDSCHUTZ · HANDLAUFSYSTEME	Boschstraße 7, D-94405 Landau/Isar 09951/6903-0, info@brem-systeme.de		
	Wandschutz Typ 13 E- Dose Kreisbohrung Querschnitt		
Bearb.: W. Mader	Z.Nr. 7.001W13	20.07.2011	M 1:1

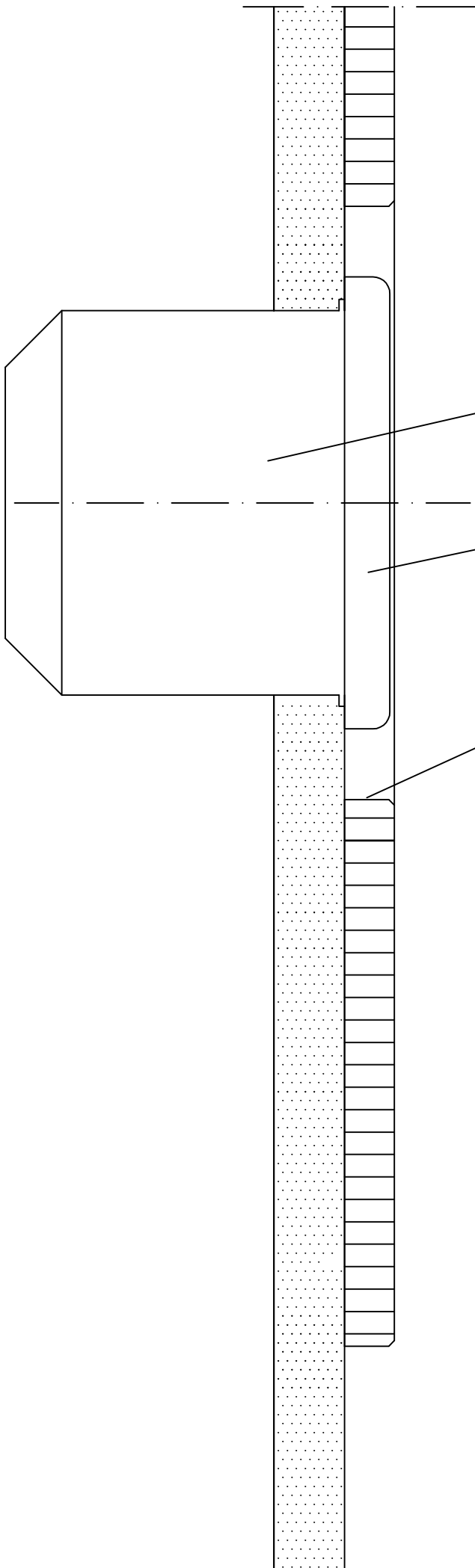

Hohlraumdose
Ø68mm

E-Dosenabdeckung
80x80mm

Aussparung 100x100mm,
Kanten bleiben schwarz



Boschstraße 7, D-94405 Landau/Isar
09951/6903-0, info@brem-systeme.de

Wandschutz Typ 13
E- Dosenausfräsung
Querschnitt

Bearb.: W. Mader

Z.Nr. 7.002W13

20.07.2011

M 1:1